

MAX17557EVKIT# Evaluation Kit

Evaluates: MAX17557 5V Output-Voltage Application

General Description

The MAX17557 5V-output evaluation kit (EV kit) provides a proven design to evaluate the MAX17557 high-voltage, high-efficiency, synchronous step-down DC-DC controller. The EV kit provides 5V/10A at the output from a 6.5V to 60V input supply. The switching frequency of the EV kit is preset to 350kHz for optimum efficiency and component size. The EV kit features Enable/UVLO Input, selectable PWM/DCM modes, resistor-programmable UVLO threshold, adjustable soft-start time, open-drain PGOOD output, and overcurrent and overtemperature protection.

Features

- Operates from a 6.5V to 60V Input Supply
- 5V Output Voltage
- Up to 10A Output Current
- 350kHz Switching Frequency
- Enable/UVLO Input, Resistor-Programmable UVLO Threshold
- Selectable PWM/DCM Modes of Operation
- Adjustable Soft-Start Time
- Programmable Soft-Stop Enable or Disable Function
- Open-Drain PGOOD Output
- Overcurrent (OCP) and Overtemperature (OTP) Protection
- Proven PCB Layout
- Fully Assembled and Tested

Ordering Information appears at end of data sheet.

Quick Start

Recommended Equipment

- MAX17557 5V-output EV kit
- 6.5V to 60V, 10A DC-input power supply
- Load capable of sinking 10A
- Digital voltmeter (DVM)

Procedure

The EV kit is fully assembled and tested. Follow the steps below to verify the board operation. **Caution: Do not turn on power supply until all connections are completed.**

- 1) Set the power supply at a voltage between 6.5V and 60V. Disable the power supply.
- 2) Connect the positive terminal of the power supply to the V_{IN} PCB pad and the negative terminal to the nearest PGND PCB pad. Connect the positive terminal of the 10A load to the V_{OUT} PCB pad and the negative terminal to the nearest PGND PCB pad.
- 3) Connect the DVM across the V_{OUT} PCB pad and the nearest PGND PCB pad.
- 4) Place the shunt on the jumpers JU1, JU2, JU3, and JU4 according to the intended operation (see [Tables 1, 2, 3, and 4](#) for details).
- 5) Turn on the DC power supply.
- 6) Enable the load.
- 7) Verify that the DVM displays 5V.

Detailed Description of Hardware

The MAX17557 5V-output evaluation kit (EV kit) is a proven design to evaluate the MAX17557 high-voltage, high-efficiency, synchronous step-down DC-DC controller. The EV kit provides 5V/10A at the output from a 6.5V to 60V input supply. The switching frequency of the EV kit is preset to 350kHz for optimum efficiency and component size. The EV kit features current sensing using either an external current-sense resistor for accuracy or an inductor DCR for improved system efficiency. Current foldback limits MOSFET power dissipation under short-circuit conditions. The MODE/SYNC PCB pad allows an external clock to synchronize the device. Jumper JU1 allows the selection of the mode of operation based on light load-performance requirements. The EV kit includes an EN PCB pad and jumper JU3 to enable the output at a desired input voltage. A PGOOD PCB pad is available for monitoring when the converter output is in regulation.

Setting the Input Undervoltage Lockout Level

The EN pin can be open or pulled to a voltage between 1.25V and 5.5V to turn on the controller. Figure 1 shows the possible configurations. The EN pin can be used as input undervoltage lockout detector with a typical hysteresis of 100mV. As shown in Figure 1, the input voltage at which the controller of the IC turns on, can be set with a resistor-divider connected to EN from IN to GND. Select R2 = 10kΩ and calculate R1 based on the following equation:

$$R1 = R2 \times \frac{(V_{IN_UVLO} - 1.25)}{1.25}$$

where V_{IN_UVLO} is the input voltage at which the controller should be enabled.

See Table 3 for JU3 jumper settings and descriptions of controller enable/undervoltage lockout (EN).

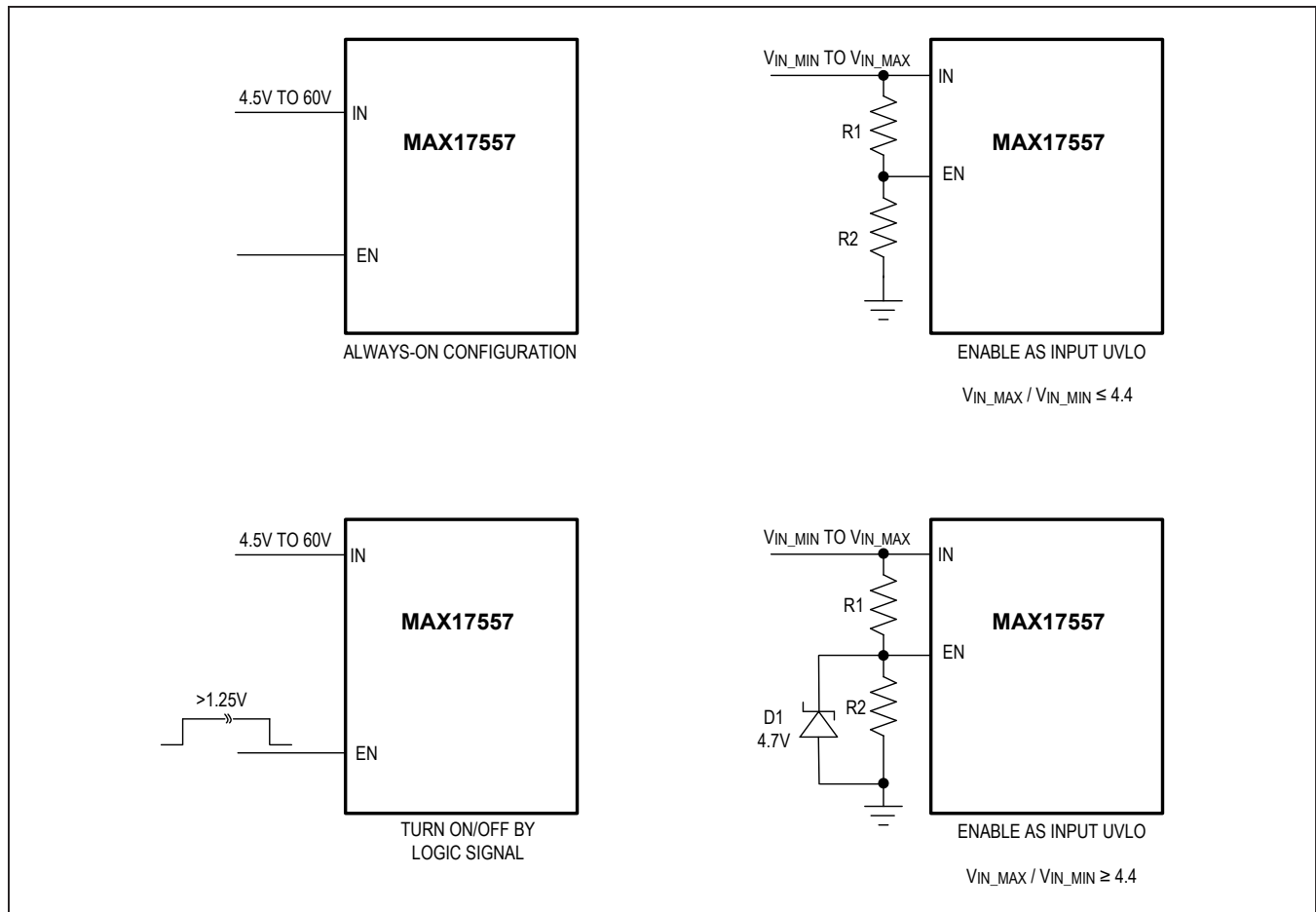

Figure 1. Setting the Input Under Voltage Lockout

Table 1. JU1: MODE/SYNC Selection

JUMPER	SHUNT POSITION	MODE/SYNC PIN	MAX17557_MODE
JU1	1-2	Connected to V _{CCINT}	DCM Mode of Operation
	2-3	Connected to GND	PWM Mode of Operation

Table 2. JU2: Overcurrent Protection Mode Select

JUMPER	SHUNT POSITION	ILIMSEL	MODE
JU2	1-2	Connected to V _{CCINT}	Latch-off Mode
	2-3	Connected to GND	Foldback Mode

Table 3. JU3: Controller Enable/Under Voltage Lock Out (EN) Description

JUMPER	SHUNT POSITION	EN	MAX17557 OUTPUT
JU3	Not installed	Unconnected	Enabled
	1-2	Connected to the input UVLO divider midpoint.	Enabled, UVLO level is set by the resistor divider from V _{IN} to GND.
	2-3	Connected to GND	Disabled

MODE/SYNC

The device’s Mode Selection and External Synchronization (MODE/SYNC) pin can be used to select the PWM or DCM modes of operation. The logic state of the MODE/ SYNC pin is latched when the V_{CCINT} and EN voltages exceed the respective UVLO rising thresholds and all internal voltages are ready to allow LX switching. State changes on the MODE/SYNC pin are ignored during normal operation. Refer to the MAX17557 IC data sheet for more information on the PWM and DCM modes of operation. Table 1 lists JU1 jumper settings that can be used to configure the desired mode of operation.

The internal oscillator of the device can be synchronized to an external clock signal on the MODE/SYNC pin. The external synchronization clock frequency must be between 1.1 x f_{SW} and 1.4 x f_{SW}, where f_{SW} is the frequency of operation set by R3. The minimum external clock high pulse width should be greater than 50ns.

Adjusting Output Voltage

The output voltage of the converter is set by connecting a resistor-divider to FB from the output to GND (Figure 2). Select R3 using the following equation, based on the offset introduced on the output voltage by the FB leakage. Let α be the offset introduced on the output voltage:

$$R3 \leq \frac{\alpha}{I_{FB}}$$

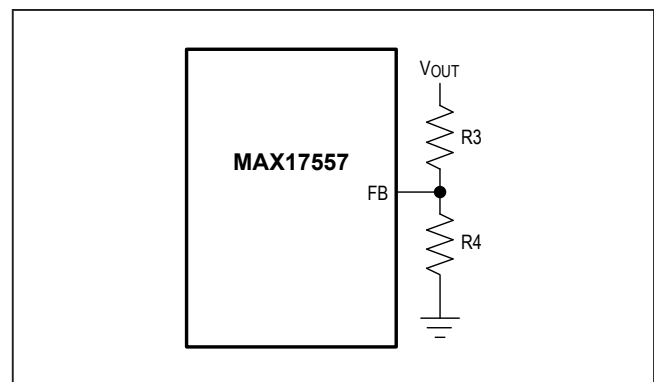

Figure 2: Adjusting Output Voltage

where:

α = offset introduced on the output voltage

I_{FB} = FB leakage current (±100nA max)

For example, for V_{OUT} = 5V, α = 0.1% of V_{OUT} (= 5mV).

$$R3 \leq 50k\Omega$$

Calculate R4 with the following equation:

$$R4 = \frac{R1}{\left(\frac{V_{OUT}}{0.8} - 1\right)}$$

Soft-Start Capacitor Selection

Soft-start time is programmed by connecting a capacitor from the SS pin to GND. An internal 5µA current source charges the capacitor at the SS pin providing a linear ramping voltage for output-voltage reference. The soft-start time is calculated based on the following equation:

$$t_{SS} = C_{SS} \times \frac{0.8V}{5\mu A}$$

Soft-Stop Enable (SSTPEN):

The device's soft-stop enable pin (SSTPEN) enables or disables the soft-stop functionality during device's power down using the EN pin. Soft-stop time is equal to soft-start time, which can be programmed by connecting a capacitor from the SS pin to GND. Connect the SSTPEN pin to V_{CCINT} or GND to enable or disable the soft-stop function, respectively. [Table 4](#) lists JU4 jumper settings that can be used to configure the soft-stop feature.

Frequency Selection (RT)

The selection of switching frequency is a tradeoff between efficiency and component size. Low-frequency operation increases efficiency by reducing MOSFET switching losses and gate-drive losses, but requires a larger inductor and/or capacitor to maintain low output-ripple voltage. The switching frequency of the device can be programmed between 100kHz and 2.2MHz using the RT pin. Connect a resistor from RT to GND to set the regulator's switching frequency. Leave RT open for the default 350kHz frequency. The following formula can be used to find the required resistor for a given switching frequency.

$$R_{RT} = \frac{19 \times 10^3}{f_{SW}} - 1.7$$

where R_{RT} is in kΩ and f_{SW} is in kHz. Leaving the RT pin open causes the device to operate at the default switching frequency of 350kHz.

Table 4. JU4: SSTPEN Selection

JUMPER	SHUNT POSITION	MODE/SYNC PIN	MAX17557 CONDITION
JU4	1-2	Connected to V _{CCINT}	ENABLE Soft-Stop Function
	2-3	Connected to GND	No Soft-Stop Function

MAX17557 EV Kit Performance Report

$V_{IN} = 24V$, $V_{SSTPEN} = GND$ unless otherwise noted.

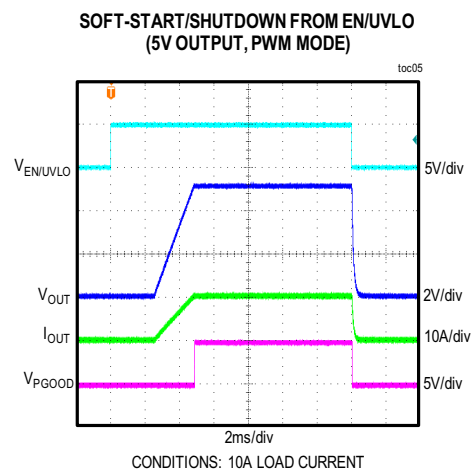
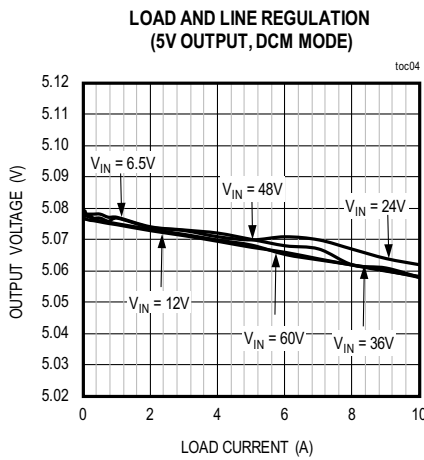
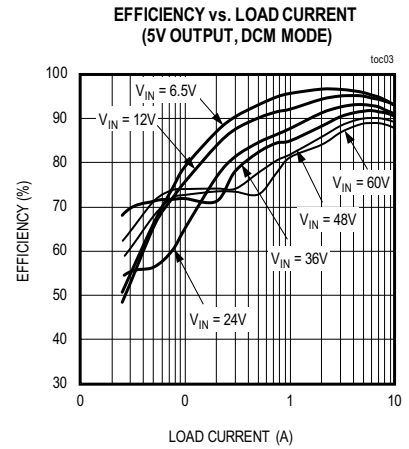
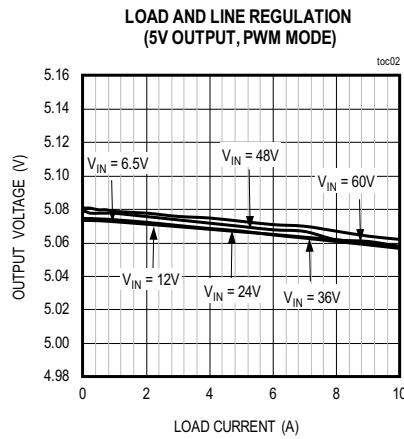
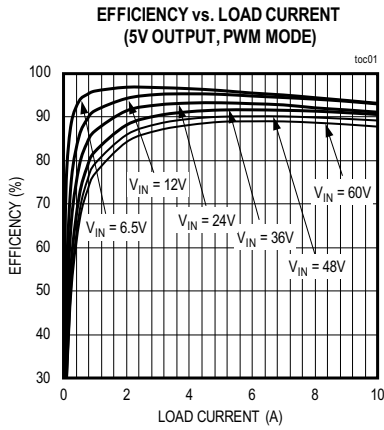

MAX17557 EV Kit Performance Report (continued)

$V_{IN} = 24V$, $V_{SSTPEN} = GND$ unless otherwise noted.

SOFT-START/SHUTDOWN FROM EN/UVLO (5V OUTPUT, PWM MODE)

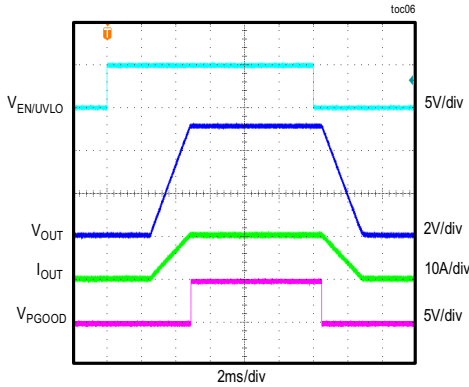

CONDITIONS: 10A LOAD CURRENT, $V_{SSTPEN} = V_{CCINT}$

SOFT-START WITH 2.5V PREBIAS, (5V OUTPUT, PWM MODE)

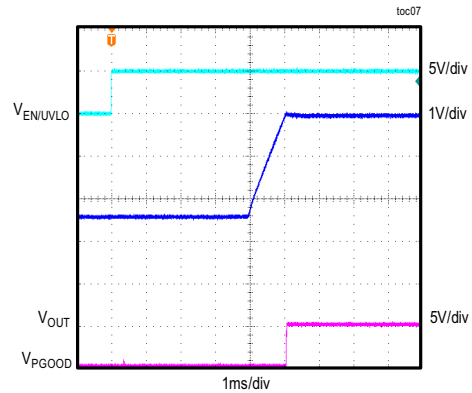

LOAD TRANSIENT RESPONSE (5V OUTPUT, PWM MODE)

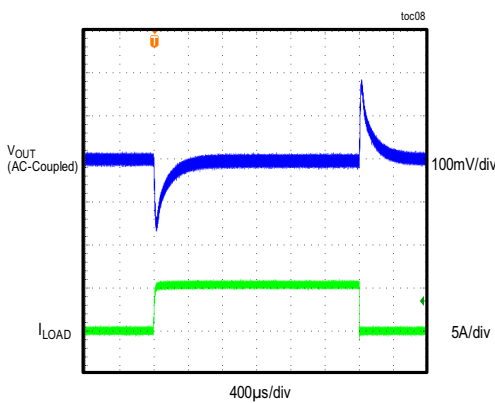

CONDITIONS: LOAD CURRENT STEPPED FROM 0A TO 5A

LOAD TRANSIENT RESPONSE (5V OUTPUT, PWM MODE)

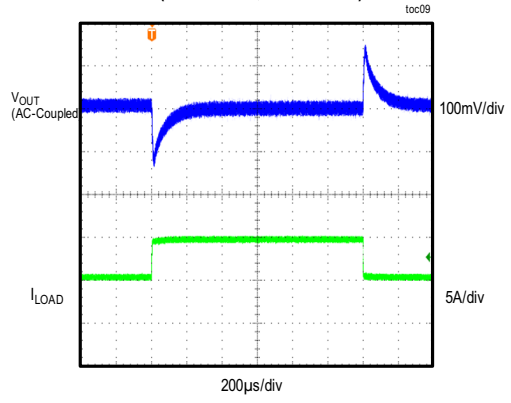

CONDITIONS: LOAD CURRENT STEPPED FROM 5A TO 10A

LOAD TRANSIENT RESPONSE (5V OUTPUT, DCM MODE)

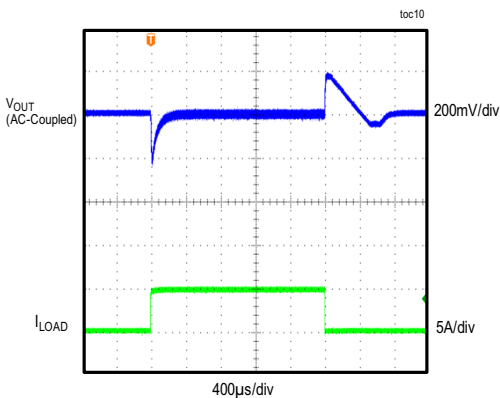

CONDITIONS: LOAD CURRENT STEPPED FROM 0.1A TO 5A

BODE PLOT, 5V OUTPUT
CONDITIONS: 10A LOAD CURRENT

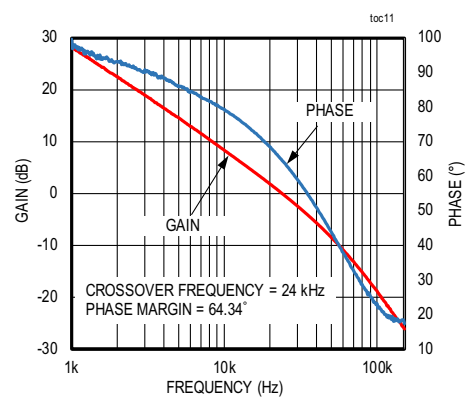

Component List

SUPPLIER	WEBSITE
Coilcraft, Inc.	www.coilcraft.com
Murata Americas	www.murataamericas.com
Panasonic Corp.	www.panasonic.com
Renesas Electronics	www.renesas.com
Diodes Inc.	www.diodes.com

Note: Indicate that you are using the MAX17557 when contacting these component suppliers.

Ordering Information

PART	TYPE
MAX17557EVKIT#	EVKIT

MAX17557 EV System Bill of Materials

No.	Description	Quantity	Designator	Part Number
1	0.1 μ F 10%, 100V ,X7R,Ceramic capacitor (0603)	2	C1,C2	MURATA GRM188R72A104KA35
2	4.7 μ F 20%, 80V ,X7R,Ceramic capacitor (1210)	2	C3,C4	MURATA GRM32ER71K475ME14
3	150 μ F,20%,80V,ELECT,13mm	1	C5	PANASONIC EEV-FK1K151Q
4	1 μ F 10%, 16V ,X7R,Ceramic capacitor (0603)	1	C6	MURATA GRM188R71C105KA12
5	10 μ F 10%, 10V ,X7R,Ceramic capacitor (0805)	1	C7	MURATA GGRM21BR71A106KE51
6	15000pF,10%,50V,X7R,0402,Ceramic capacitor(0402)	1	C8	MURATA GRM155R71H153KA12
7	0.47 μ F,10%,16V,X7R, Ceramic capacitor(0603)	1	C9	MURATA GRM188R71C474KA88
8	0.1 μ F,10%,50V,X7R, Ceramic capacitor(0402)	1	C10	MURATA GRM155R71H104KE14
9	180 μ F 20%, 6.3V ,X7R,Ceramic capacitor (1210)	1	C11	PANASONIC EEFSE0J181R
10	10 μ F 10%, 10V ,X7R,Ceramic capacitor (1210)	2	C13,C14	MURATA GRM32DR71A106KA01
11	1000pF,10%,100V,X7R,0402,Ceramic capacitor(0402)	1	C15	MURATA GRM155R72A102KA01
12	10nF,10%,50V,X7R,0402,Ceramic capacitor(0402)	1	C18	MURATA GRM155R71H103JA88
13	120pF,2%,50V,X7R,0402,Ceramic capacitor(0402)	1	C19	MURATA GRM1555C1H121GA01
14	Diode PIV=100V; IF=1A	1	D1	DIODES INCORPORATED DFSL1100-7
15	3-pin header (36-pin header 0.1" centers)	4	JU1,JU2,JU3,JU4	Sullins: PEC03SAAN
16	INDUCTOR, 3.3 μ H, 19.4A	1	L1	COILCRAFT XAL7070-332ME
17	N-CHANNEL POWER MOSFET(LFPAK) PD-(45W); I-(25A); V-(60V)	1	Q1	RENESAS RJK0651DPB-00#J5
18	N-CHANNEL POWER MOSFET(LFPAK) D-(65W); I-(45A); V-(60V)	1	Q2	RENESAS RJK0653DPB-00#J5
19	RES+,0 Ω ,1%,0402	8	R1, R4, R7, R9, R12-R14, R19	
20	RES+,2.2 Ω ,1%,0402	1	R2	
21	RES+,0.005 Ω ,1%,1.5W,2010	1	R8	TT ELECTRONICS LRMAT2010-R005F
22	RES+,7.5K Ω OHM,1%,0402	1	R17	
23	RES+,100K Ω OHM,1%,0402	1	R18	
24	RES+,95.3K Ω OHM,1%,0402	1	R20	
25	RES+,17.8K Ω OHM,1%,0402	1	R21	
26	Buck Controller MAX17557ATP+	1	U1	MAX17557ATP+

MAX17557 EV System Schematic

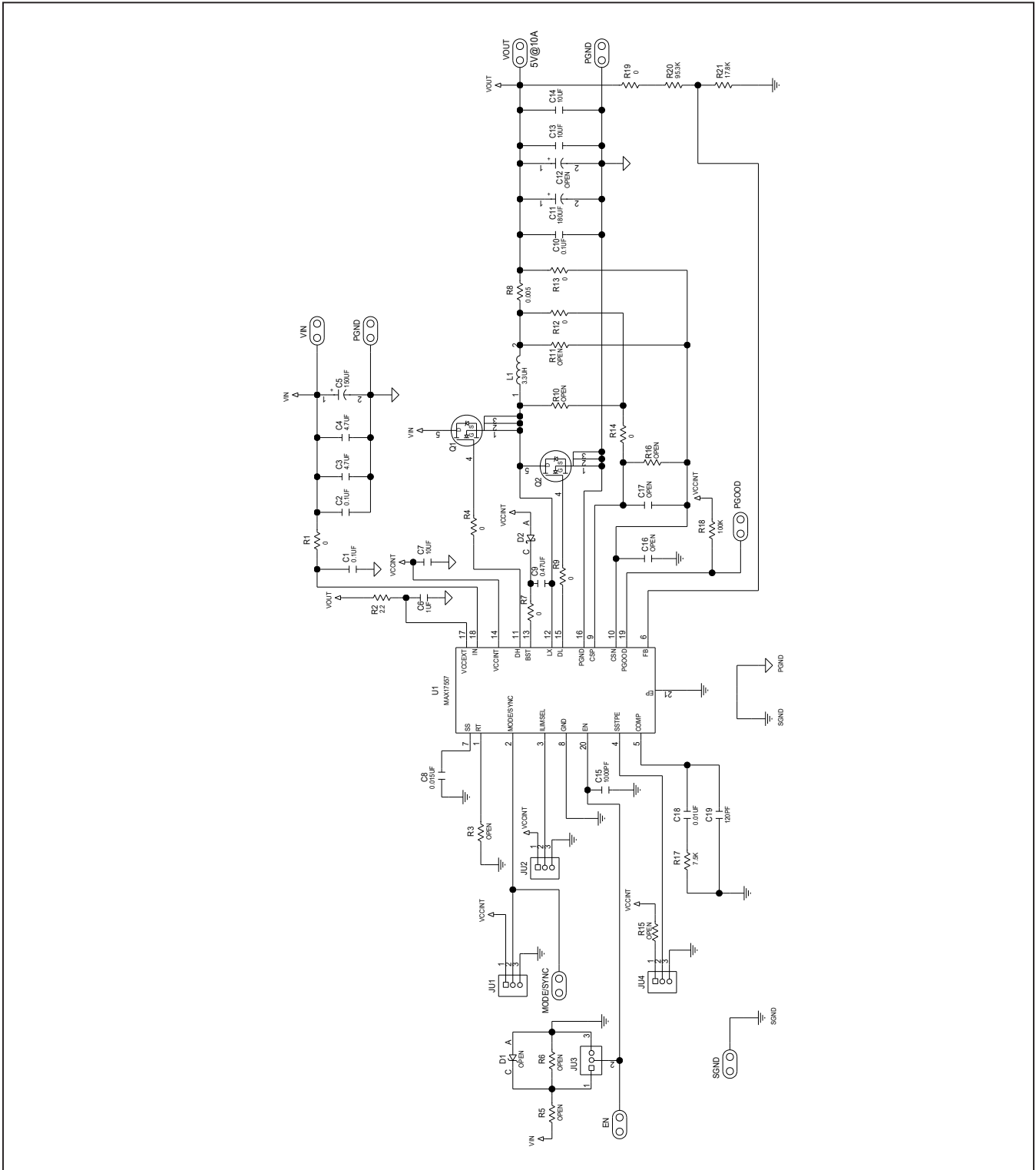

MAX17557EVKIT# Evaluation Kit

Evaluates: MAX17557 5V
Output-Voltage Application

MAX17557 EV System PCB Layout

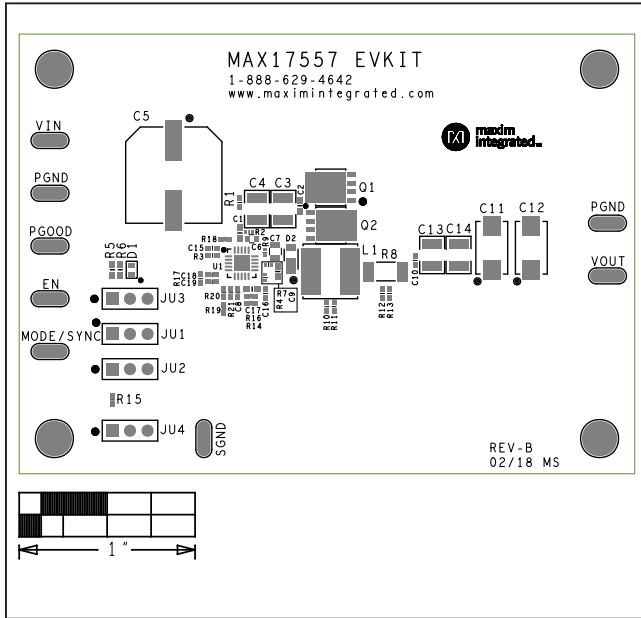

MAX17557 EV Kit Silk Top

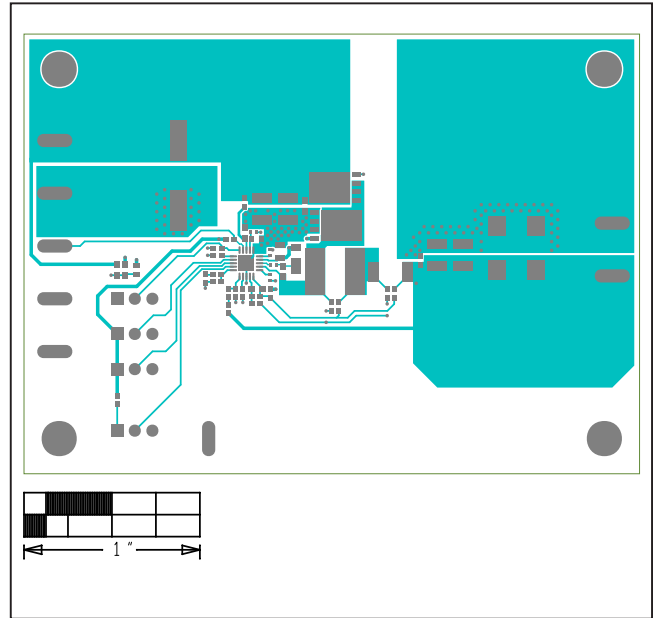

MAX17557 EV Kit Top

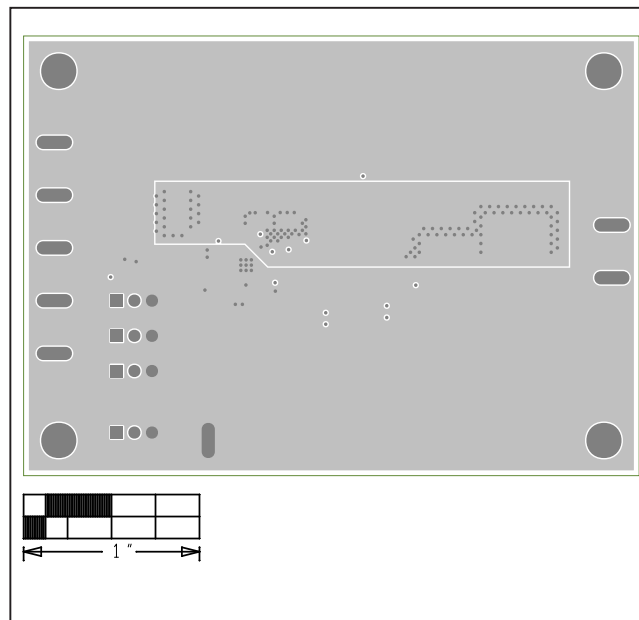

MAX17557 EV Kit L2-GND

MAX17557 EV System PCB Layout (continued)

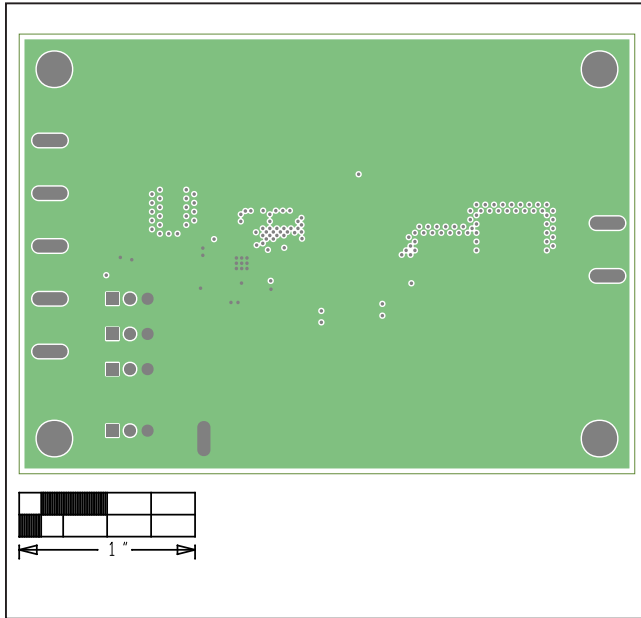

MAX17557 EV Kit L3-GND

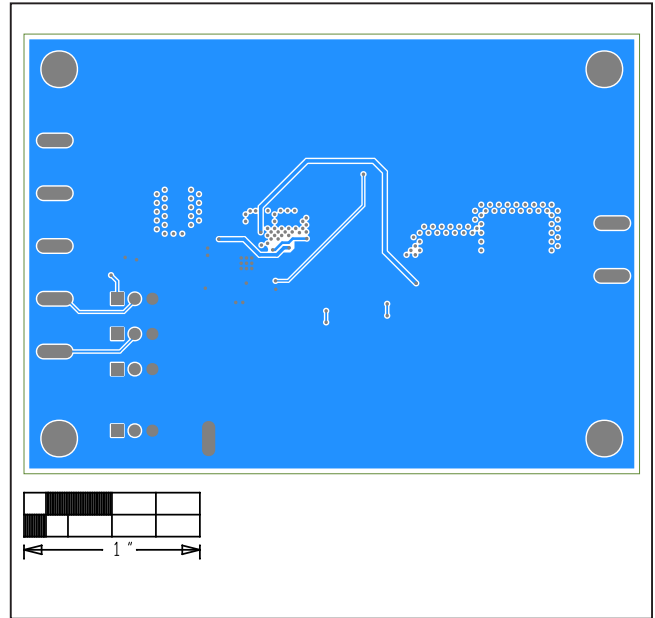

MAX17557 EV Kit Bottom

Revision History

REVISION NUMBER	REVISION DATE	DESCRIPTION	PAGES CHANGED
0	8/17	Initial release	—
1	3/18	Changed the document title. Updated the following sections: <i>General Description</i> , <i>Features</i> , <i>Quick Start</i> , and <i>Detailed Description of Hardware</i> . Added Table 1 and Table 4, and updated Table 2 and Table 3. Updated the MAX17557 EV Kit Performance Report, the MAX17557 EV System Bill of Materials, the MAX17557 EV System Schematic, and the MAX17557 EV System PCB Layout.	1-10
1.5		Corrected typo.	7

For pricing, delivery, and ordering information, please contact Maxim Direct at 1-888-629-4642, or visit Maxim Integrated's website at www.maximintegrated.com.

Maxim Integrated cannot assume responsibility for use of any circuitry other than circuitry entirely embodied in a Maxim Integrated product. No circuit patent licenses are implied. Maxim Integrated reserves the right to change the circuitry and specifications without notice at any time.